

1

Kit 145197

FORD Focus (Mk.III), 5-dr Estate, 11-18



ISO 1154-E

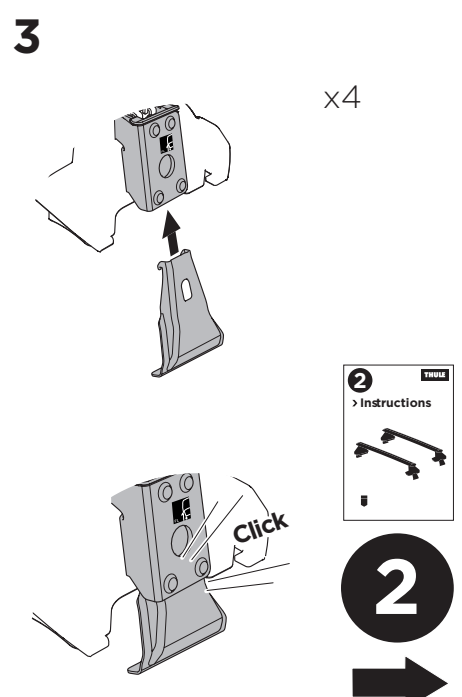
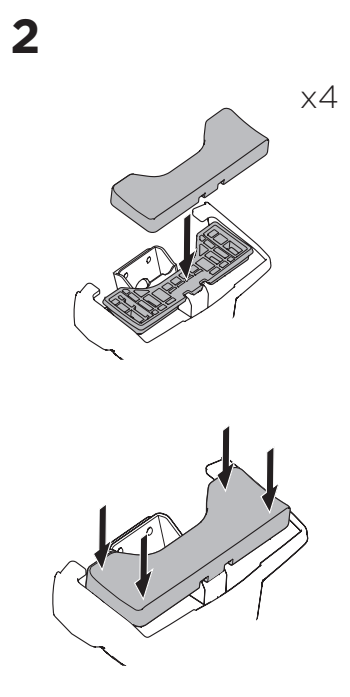
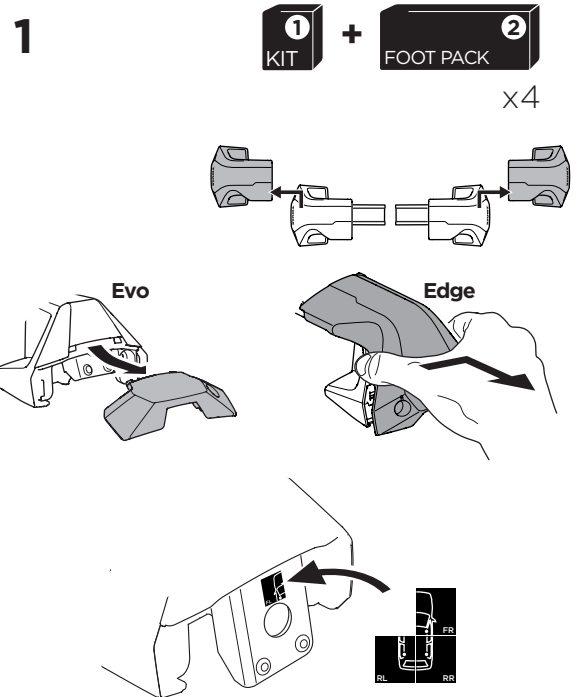
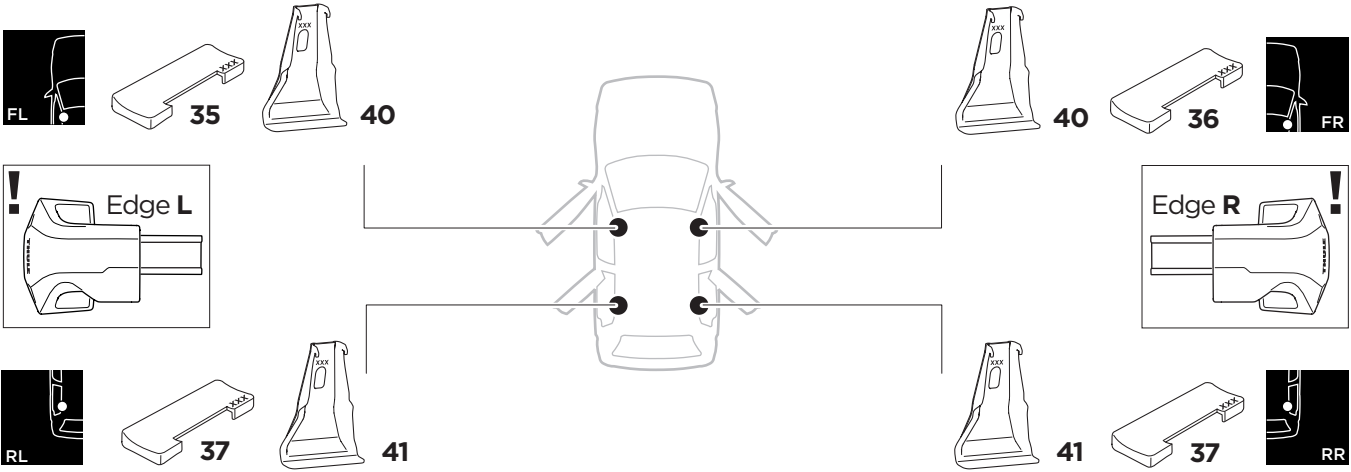
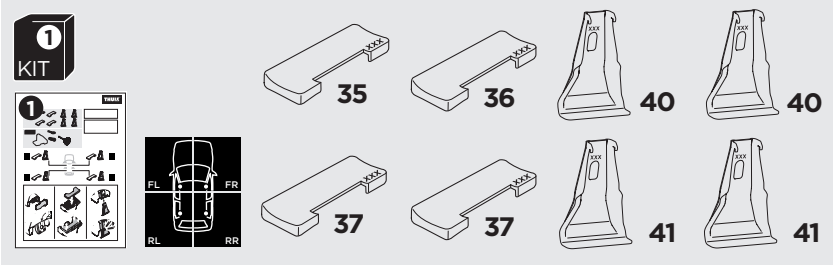



THULE WingBar Evo	THULE WingBar Edge	THULE WingBar	THULE SquareBar Evo	Evo X (scale)	Edge X (scale)
FORD Focus (Mk.III), 5-dr Estate, 11-18				40,5	P
THULE ProBar Evo	THULE SlideBar Evo				X (mm/inch)
FORD Focus (Mk.III), 5-dr Estate, 11-18				1056 mm / 41 5/8"	



THULE WingBar Evo	THULE WingBar Edge	THULE WingBar	THULE SquareBar Evo	Evo Y (scale)	Edge Y (scale)
FORD Focus (Mk.III), 5-dr Estate, 11-18				33,5	L
THULE ProBar Evo	THULE SlideBar Evo				Y (mm/inch)
FORD Focus (Mk.III), 5-dr Estate, 11-18				986 mm / 38 7/8"	

	W (mm/inch)	Z (mm/inch)
FORD Focus (Mk.III), 5-dr Estate, 11-18	790 mm / 31 1/8"	250 mm / 9 7/8"

